

# mag 2.

## THE FLOWER OF LIFE:

### THE MAGURA SYSTEM OF 12

the energy pattern of our vital power,  
the model and structure of our organic universal life system and original world  
order is a 12-petalled flower.

our ancestors called it the flower of life.  
it might have been called MAGURA in Magyar.

***MAG-URA = MAG-ERŐ:***  
***MASTERY and POWER of the SEED.***

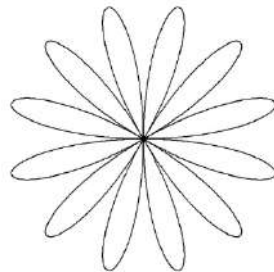

this pattern of 12 is born from the trinary MAG or SEED structure and  
the four elements which spring from the binary seed of the seed (3x4).  
the MAGURA is the archaic, invincible, eternal, omnipresent and omnipotent  
structure and forcefield that is waiting inside and around to reorder,  
reharmonize, rebalance us: to reintegrate us into our **original cosmic-human-**  
**natural *modus vivendi***, consciousness and mechanism.

the round table waiting for the leaders and peoples of the world to reunify  
according to the original, literally MAGical global geo-cultural-political system.

## ***THE TRINARY MAG:***

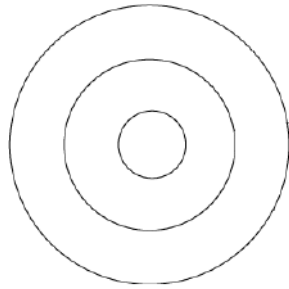

1.heart&soul, 2.mind&consciousness, 3.body&material world

## ***THE 4 ELEMENTS:***

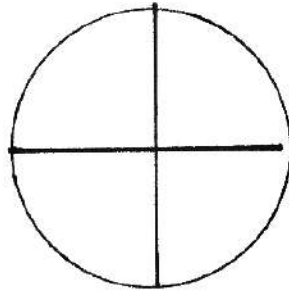

4 Elements: Water, Fire, Air and Earth  
see all the references to this: 4 Archangels, 4 Cardinal Directions, 4 Dimensions  
of Space-Time etc. see the 4 Pillars later

## ***3 and 4:***

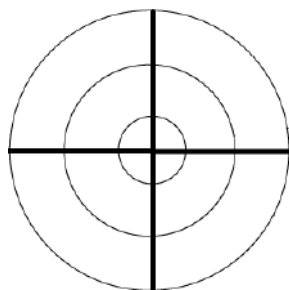

# *THE FLOWER OF LIFE, STRUCTURE OF WATERCRYSTALS:*

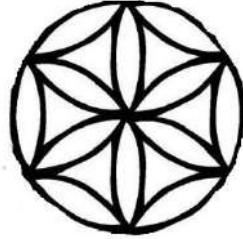

## *THE MAG-IC SYSTEM OF 12:*

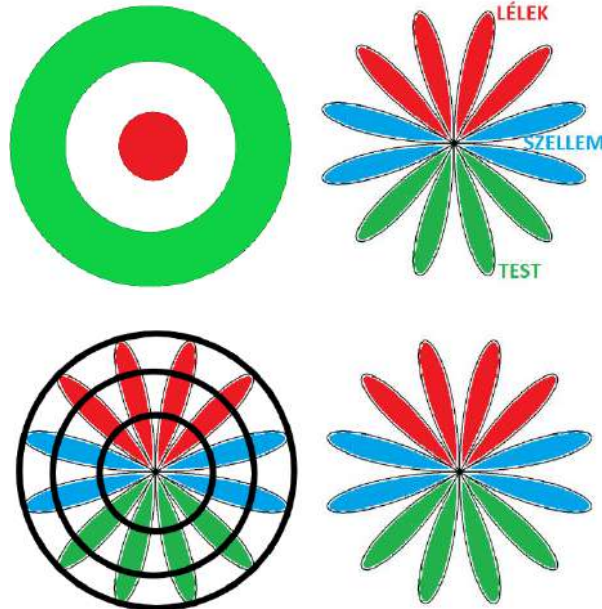

12 states of soul, mind and body, as the four elements effect them. the 12 contain a diversity of balances, harmonies & orders. see all the 12s in history, mythology, religion, society:

12 hours of time, 12 months, 12 zodiac signs, 12 Solar houses, 12 tribes of Israel, 12 main gods of the Olympos, 12 apostles of Jesus, 12 knights of the Round Table, 12 personality archetypes or roles etc. these all mean something deeply effecting us. in reality, there are 12 tribes of all humanity. and 12 chakras of the whole body.

occult 12s from the EU flag to MJ-12

Heavenly Jerusalem in the Bible: full of 12s. it is the basic system of our life and the life that surrounds us, from cosmic to natural, macrocosmic to microcosmic.

## ***SPINNING DYNAMISM & MOVEMENT:***

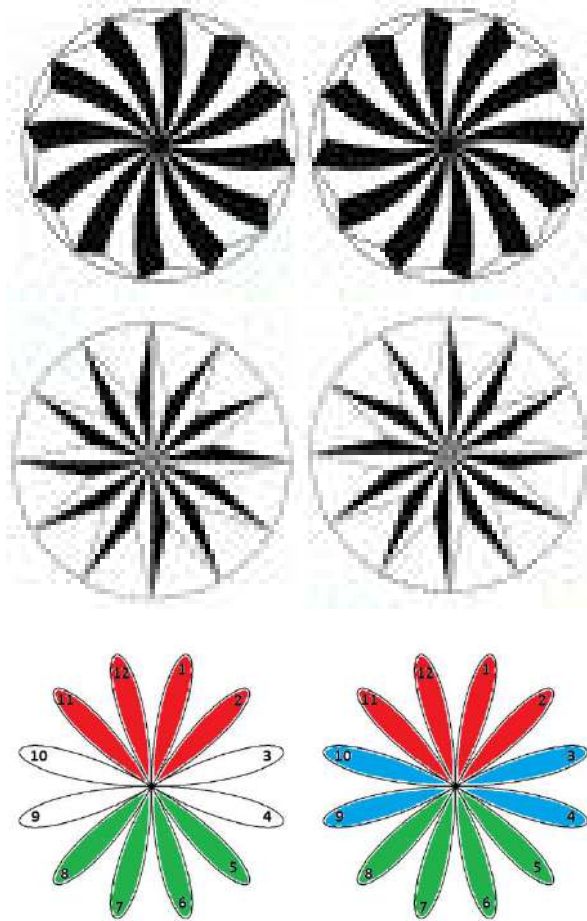

spinning “bio” magneticism, a force and force-field  
whirling, rotating magnetic field: source of anti-gravity, levitation

the initiation passage is operated by this whirling dynamism within the MAG:  
see the 12 works of Heracles, the stations of the Calvary, the mythical Hero’s  
Journey etc.

## ***MAG ÓRA - MAG CLOCK:***

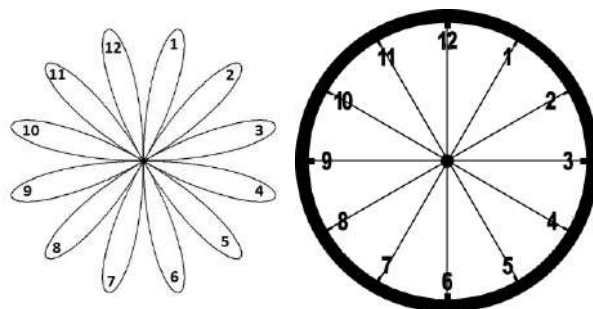

the basic structure of time: the 12 hours.

## **12 SCHOOL SUBJECTS:**

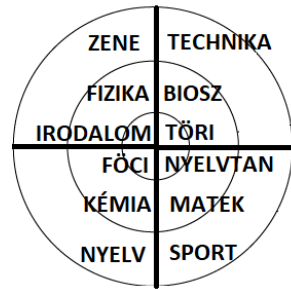

technical skills, sports, communication skills, music,  
biology, maths, chemistry, physics,  
history, language, geography, literature

## **12 PERSONALITY ARCHETYPES/ROLES:**

Regular, innocent, lover, caretaker,  
rebel, explorer, jester, sage,  
creator, wizard, hero, ruler.

## **THE HERO'S JOURNEY:**

1. Ordinary world (Limited awareness of a problem)
2. Call to adventure (Increased awareness)
3. Refusal of the call (Reluctance to change)
4. Meeting with the mentor (Overcoming reluctance)
5. Crossing the threshold (Committing to change)
6. Tests, allies and enemies (experimenting with first change)
7. Approach the inmost cave (Preparing for a big change)
8. Ordeal (Attempting a big change)
9. Reward (seizing the sword) (Consequences of the attempt – improvements and setbacks)
10. Road back (Rededication to change)
11. Resurrection (Final attempt at a big change)
12. Return with the elixir (Final mastery of the problem)

this is Joseph Campbell's system based on all ancient myths and mythologies:  
the process of passage and initiation

# THE MAGYAR HOLY CROWN:

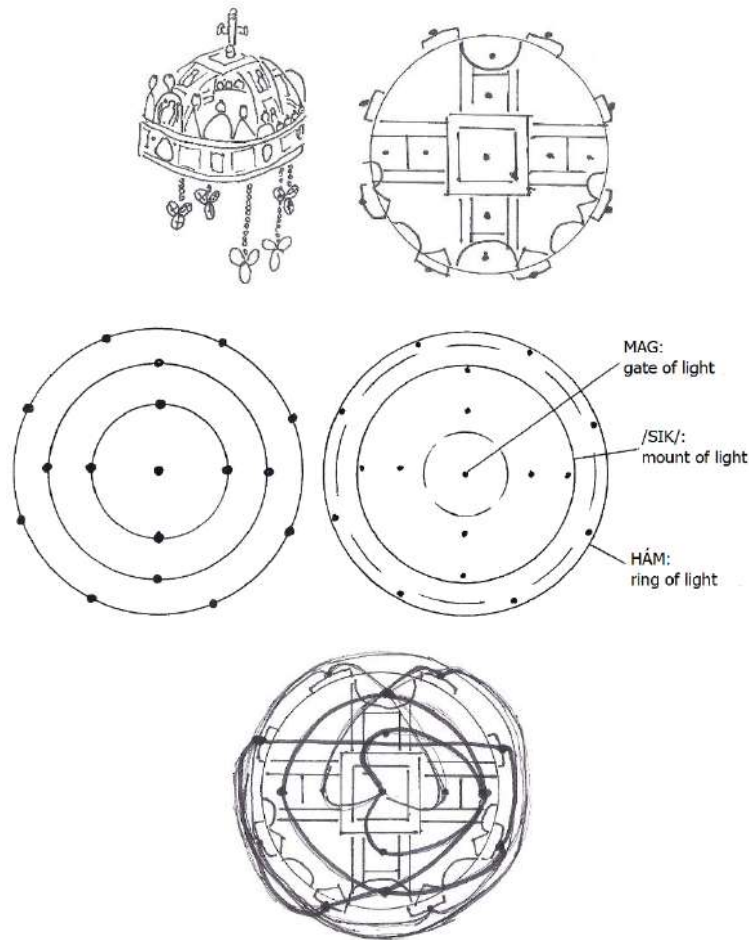

the historical, mystical Holy Crown operates as an atom reactor or particle accelerator. there is a passage of energy (Light) through and within the object, which obviously concerns its resonating activity: it is an electromagnetically active, living object. indeed, “it” is personalized by the Magyars as *Őfelsége*: His/Her Majesty.

two opposite circulations form two hearts. it is the Crown of Love, Light and Life.

the Crown operates the MAGURA.

it represents – and presents, actualizes the basic operation of the Divine Kingdom. this is the tradition of the old, original holy crowns: initiation instruments, bringing higher dimensions of seeing and understanding – as well as physical intelligence. they are not demonstration items of bloody royal imperial power backed by no personal merit or divine initiation, as in the newer aristocracy, tradition and paradigm of wrong motives.

# *The 4 PILLARS of the UNIVERSE:*

*THE FRUIT of LIFE:*

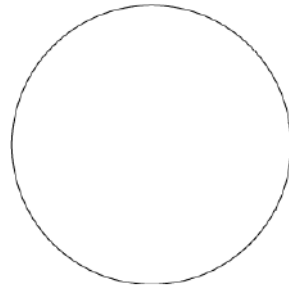

*THE SEED of LIFE:*

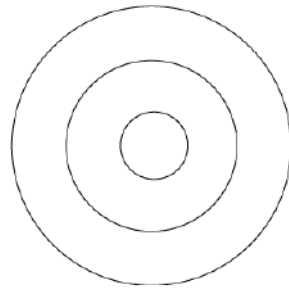

*THE TREE of LIFE:*



*THE FLOWER of LIFE:*

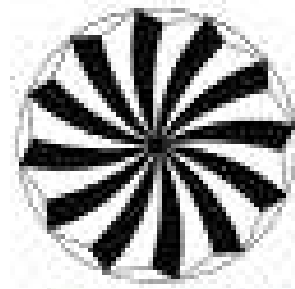

# *The 4 MAIN LAWS and 4 FORMS of ENERGY:*

**the Fruit:** represents holography. unity, Oneness, belonging, stillness.  
also represented as a Point.

**the Seed:** represents magnetism. creation and attraction.  
pulse, process, sequence, creation, movement, expansion, becoming.  
also represented as three rotating colours, arms or legs.

**the Tree:** electricity, wave nature. a self-generating and self-sustaining flow,  
expansion. infinite, eternal flow, circulation. torus: an eternal spiral or  
lemniscate.

**the Flower:** represents the fractal prism mechanism. cyclical, rotating passage.  
development, causality, connection, time. also represented as spiral.

these are 4 stages, 4 figures, 4 powers of Creation. 4 main laws.  
they also correspond to the 4 Archangels, 4 directions (North, South, East, West  
as up down, left, right), the 4 virtues (cleverness, temperance, fortitude,  
fortitude), the 4 dimensions of geometry (points, lines, planes, solids) and  
meditation (concentration, connection, circulation, unity expansion),  
4 levels of interpretation etc.

**free cosmic-human-natural energy is present and available everywhere, as  
coded in the Seed, the Tree, the Flower and the Fruit**



the 4 Pillars also correspond to

## The 4 ROYAL EMBLEMS of the MAGYAR KINGDOM:



**the Fruit = the ORB or “Apple of the Country”**, a homogenous golden ball held in the left hand, representing Oneness,

**the Seed = the MANTLE or Cape**, a semi-circular cloth woven with gold in a pattern of three distinct, concentric lanes worn over the shoulders, representing Protection,

**the Tree = the SCEPTRE**, a golden wand with a huge crystal at the end held in the right hand, representing Will,

**and the MAGURA Flower = the CROWN**, a golden triple headpiece with gems, crystals, pearls and enamel-painted images of God, Jesus, Mary, archangels, saints and apostles

worn on the head, representing Mastery and Power.

you could say, the Magyar Holy Crown is a portal, a channel,  
the Carpathian Ark of Covenant.

the Crown is a model of the Kingdom.

God’s Kingdom on Earth means: to live by the MAGURA: it is an inner and outer code of existence and conduct.

these represent the 4 instruments of power and consciousness  
that a true sovereign (originally every sovereign human being) possesses.

the story of Adam and Eve in the Bible is our original myth, common collective psychic and energetic, genetic imprint. happiness, wholeness in Paradise with the Tree, the Apple, the Seed and the Flower of Life refers to man with all his/her capacities. ancient myths and symbols correspond to each other and to the most ground-breaking physical and metaphysical results e.g. Professor Emoto's water crystals, paranormal and psychic phenomena, quantum physics, holography, string-theory etc.

## **THE TREE OF LIFE and the APPLE:**

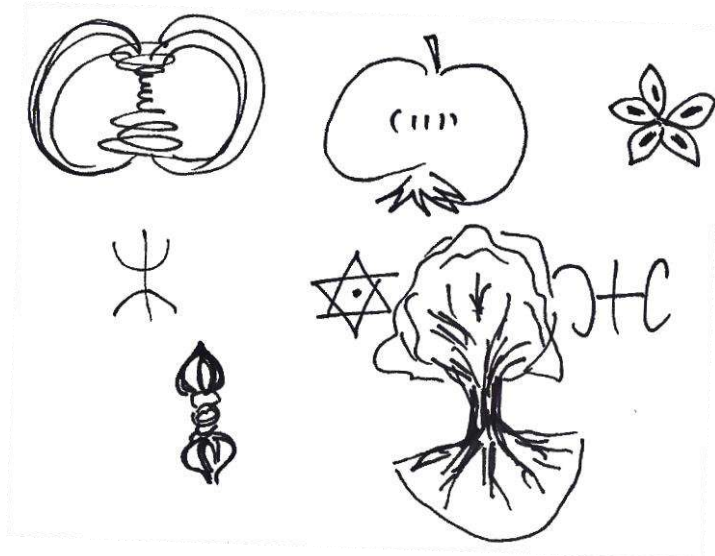

self-sustaining flow within the torus- like an apple or a tree. Berber, Tibetan, East Asian etc. signs of MAG and MAGURA consciousness

## **ETERNITY, GOD, FLOWER, SEED, MAN:**

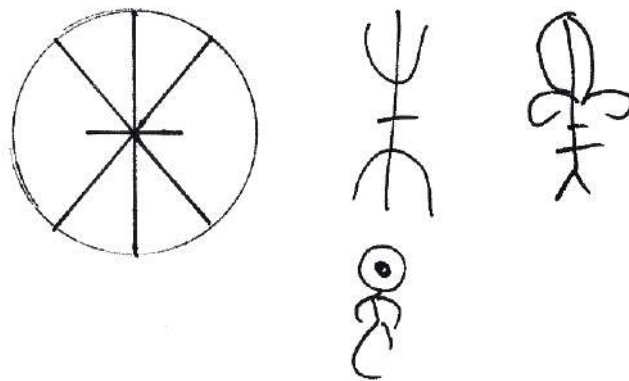

Eternal Life, unity of Three Worlds,  
flower-like Magyar *rovás* (runic) ligature sign of the Egy-Is-Ten or One God:  
both He and She!

# *COMPLEX DIVERSITY, PATTERN & SIGN OF WATER-BASED LIFE:*

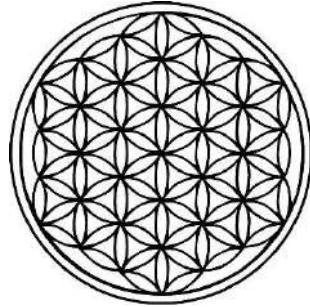

ancient symbol. variations on the basic pattern: kaleidoscope. analogy: centres are also edges. holography: the One and the All, part and whole are the same. that is exactly what the MAG is: the core and the core's core at the same time!  
(see parts of the MAG: MAG-SZIK-HÁM in Magyar)

## *MAGO: TOWER, TEMPLE, EDUCATION & GAME BASED on the MAGURA*

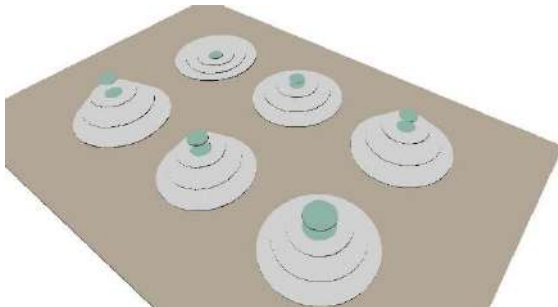

based on the 12 school subjects

# *12 KEY POLITICAL-PUBLIC TOPICS / the ROUND TABLE:*

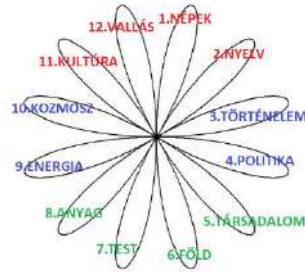

people, language, history, politics,  
society, Earth, body, matter,  
energy, cosmos, culture, religion

so what is to be done?

to return to our original Eden, we need to re-learn ourselves and our world.  
a coordinated common global public administration reform and individual  
constitutional reform is needed, ACCORDING TO THE ORDER WITHIN THE  
UNIVERSAL MAGURA MODEL.

global Round Table of nations is needed. rediscovery of our 12 chakras is  
needed.

this is how the old-new human journey begins, from darkness back to the Light.  
it is the story of the prodigal child of God.

ZsVK. 2023.

my previous works leading to this one:  
The Pearl booklet @ [www.amagdala.hu](http://www.amagdala.hu)  
& [www.mag-ura.com](http://www.mag-ura.com)